

CCS Technical Documentation

RH-34 Series Transceivers

Service Tools



Contents

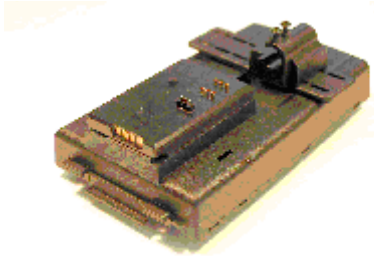

	Page No
Model 6225 Service Tools	3
Flashing and Testing Setups	8
Flashing, Testing, and Tuning with Covers on	8
Service Setup 1.....	9
Service Setup 2.....	10
Service Setup 3.....	11
Automated Tuning and Alignment	12
Automated Tuning and Alignment Equipment List.....	13
GPS Testing Engine	13
GPS Testing Equipment.....	14

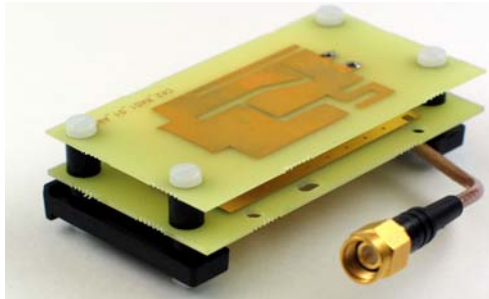

Model 6585 Service Tools



JBV-1 Docking Station	DA-12 Docking Station Adapter
0770298	0770603
	
<p>The Docking Station and the Docking Station Adapter are needed for Mbus, Fbus, RF, and audio connections. This setup allows connection between flash prommers. When the audio box is connected, it has to be connected to the phone's audio connector. The Docking Station can be powered by FPS-8 or external power supply.</p>	<p>The flash adapter allows FBUS/MBUS connections for flashing.</p>



JBA-12 Audio Box	CPL-8 GPS/RF Coupler
0770536	0770475
	
<p>The JBA-12 is required for audio testing at authorized service centers.</p>	<p>CPL-8 allows testing of the GPS antenna at AMS locations. <i>Shield Box JSX-1A is required.</i></p>



JSX-1A Shield Box	DKU-5F Flash Cable
0770346	0780738
	
<p>The Shield Box allows RF radiated tests and antenna testing. Contact the Americas AMS in Melbourne, FL for more information on how to obtain one..</p>	<p>For use with the Spirent UPST and UMPP service software. <i>Note: The cable cannot be used as a straight through USB connection cable.</i></p>

FPS-8 Flash Prommer	ADS-8 Audio Cable
0080321	0730268
	
<p>The Flash Prommer FPS-8 is used for heavy flash.</p>	<p>The Audio Cable connects to the Audio Box (JBA-12).</p>

XCS-4 Mbus/Fbus Cable	CA-5S DC Service Cable
0730178	0730283
	
<p>XCS-4 Service Cable is a modular cable for flashing DCT4 products.</p>	<p>The DC Service Cable (CA-5S) connects the docking station (JBV-1) to the charger connection (Vin) of the phone to conduct EM calibration. <i>Note: CA-5S replaces the SCB-3 cable (0730114).</i></p>

PCS-1 Power Cable	XRS-6 RF Cable
0730012	0730231
	
<p>The PCS-1 Power Cable is used to connect the service tools (JBV-1, DA-12) to an external power supply.</p>	<p>The XRS-6 Cable is used to connect service tools to RF measuring equipment.</p>



FLS-4S POS Flash Dongle	DAU-9T FBUS Data Cable
0080543	0730267
	
<p>The Point of Sale (POS) flash is a low-cost software upgrade tool. This requires XCS-1 cable and ACF-8 for operation.</p>	<p>FBUS cable DAU-9T provides a connection from the serial port of the computer to the system connector of the phone.</p>

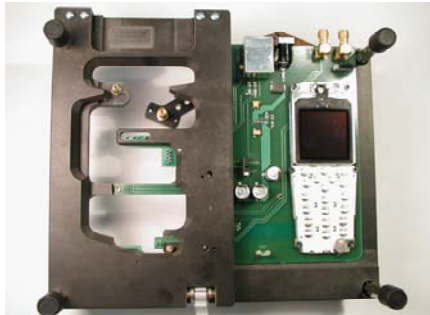

DAU-9S Cable (DB-9-Mode-10)	CA-25RS RF Test Probe
0730108	0730316
	
<p>DAU-9S is a general-purpose communications cable.</p>	<p>The CA-25RS allows testing of the CDMA RF.</p>

CA-22DS Service Connector	MJ-18 Module Jig
0730311	0770599
	
<p>This cable is used with FLS-4S or FLC-20 for bottom-connector flashing.</p>	<p>This jig allows phone PWB-level service and troubleshooting for authorized service centers.</p>

PKD-1 SW Security Device
0750018

<p>SW security device (PKD-1) is a hardware device that, when connected to the parallel (LPT) port of the PC, enables the use of service software. Without the dongle present, it is not possible to use the service software. Printers or other peripheral devices can be connected to the PC through the dongle, if needed. <i>Caution: Make sure that you have switched off the PC and the printer before making connections!</i></p>

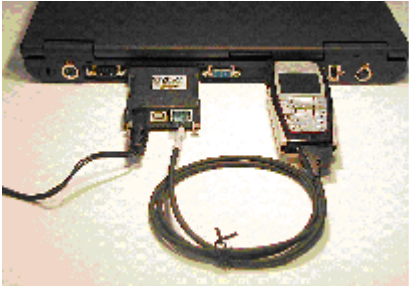
Flashing and Testing Setups

POS Flash Setup 1	POS Flash Setup 2
	
FLC-20 and CA-22DS	DKU-5F

POS Flash Setup 3	Service Center Flash Setup 4
	
FLS-4S and CA-22DS	FPS-8 prommer, JBV-1, and DA-12

Flashing, Testing, and Tuning with Covers on

Tightened performance specifications require more precise equipment and methods for testing and alignment. Manual tuning can't provide accurate results for the RH-34, which means that this test has to be automated.

These setups are intended to be with with the Phoenix Service Software. Both manual testing and automated tuning are permitted with Phoenix Service Software.

Service Setup 1

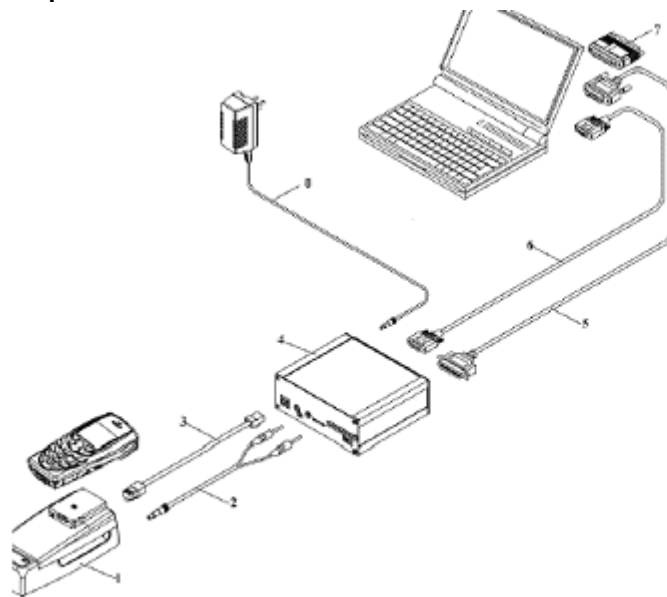

Item	Name	Type	Code
	Docking Station	JBV-1	0770298
1	Docking Station Adapter	DA-12	0770603
2	DC Power Cable	PCS-1	0770012
3	Modular Cable	XCS-4	0730178
4	Flash Prommer Box	FPS-8	0080321
5	Printer Cable (included with FPS-8)	CA-10DS	0730298
6	D9-D9 Cable (included with FPS-8)	AXS-4	0730090
7	SW Protection Key	PKD-1	0750018
8	AC Charger	ACP-8F	0680032

Service Setup 2

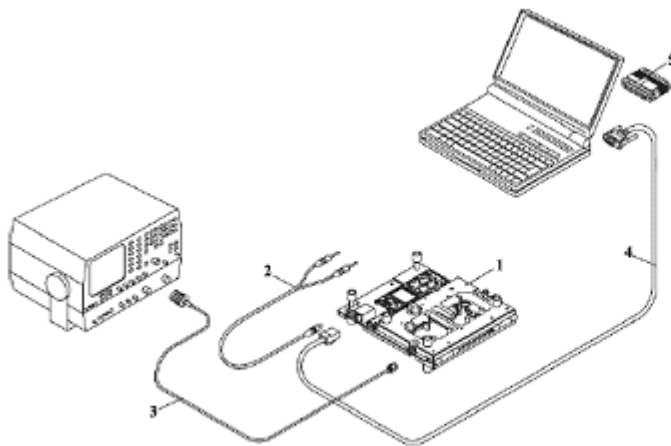

Item	Name	Type	Code
1	Module Jig	MJ-18	0770599
2	DC Power Cable	PCS-1	0730012
3	RF Antenna Cable	XRS-6	0730231
4	Service MBUS Cable	DAU-9S	0730108
5	SW Protection Key	PKD-1	0750018

Service Setup 3

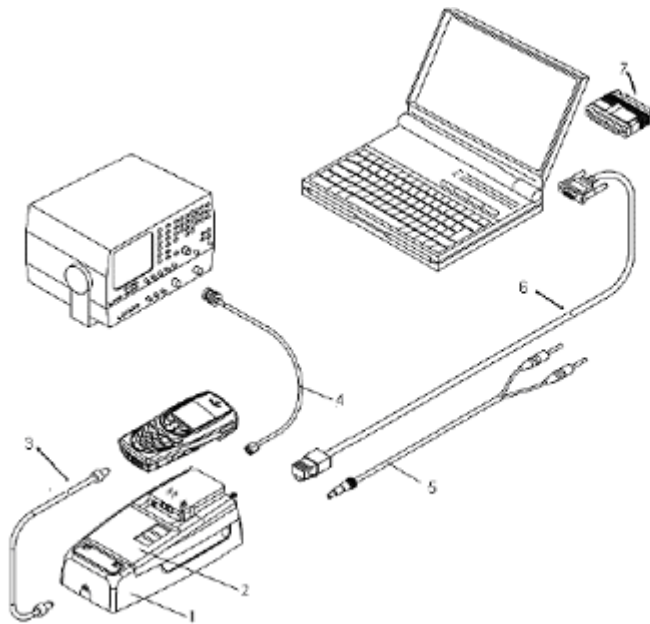

Item	Name	Type	Code
1	Docking Station	JBV-1	0770298
2	Docking Station Adapter	DA-12	0770603
3	DC Service Cable	CA-5S	0730283
4	RF Antenna Cable	XRS-6	0730231
5	DC Power Cable	PCS-1	0730012
6	Service MBUS Cable	DAU-9S	0730108
7	SW Protection Key	PKD-1	0750018

Automated Tuning and Alignment

This setup is used for tuning of the handset at Nokia Authorized Service Centers..

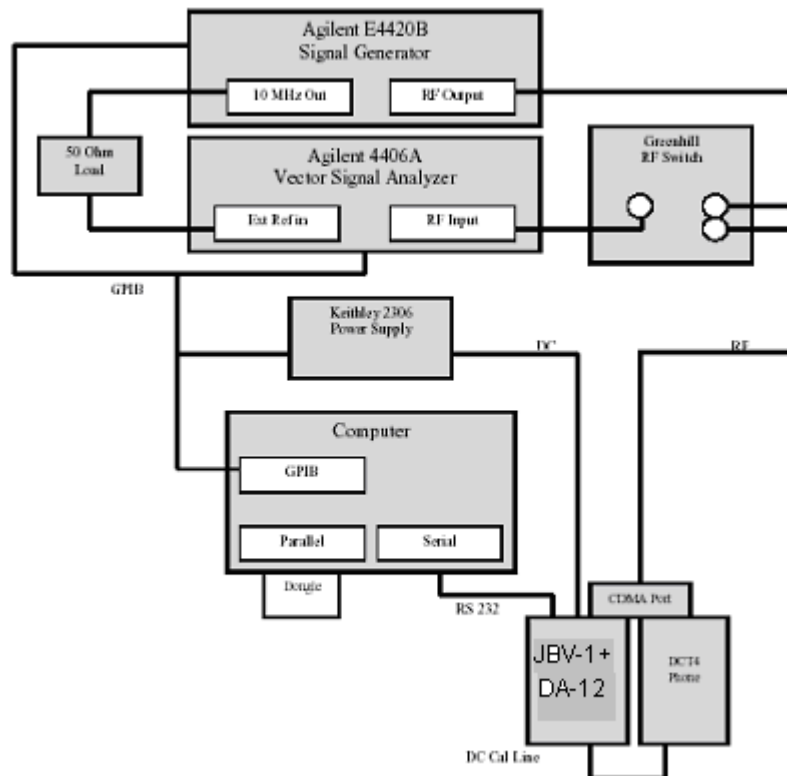

Automated Tuning and Alignment Equipment List

Item	Name	MFR	Model #	QTY	Comment
1	Vector Signal Analyzer	Agilent	E4406A	1	Options B78, BAC and BAE
2	Signal Generator	Agilent	E4421B	1	Digital signal generator with high stability oscillator and high spectral purity
3	Momentum Series	Agilent	8960C	1	CDMA tester for IS-95, IS-2000, and AMPS protocols
4	Power Supply	Keithly	K2306	2	Programmable with sense wire
5	Win2000 PC				Dell with Pentium III or above, network card, 256M RAM, 20GB HD, CD-ROM, etc.
6	NI-GPIB Interface	NI	GPIB-USB-A	2	USB to GPIB adapter (184983G-01)
7	Docking Station	Nokia	JBV-1	1	Consult your local Nokia After Market Services office for more information
8	RF Switches	Green Hill	TVi9901	1	Consult your local Nokia After Market Services office for more information

Note: A Test Sequence File is required to perform "Auto tune" on this phone. In addition, Phoenix needs to have the Auto Tune function installed. Consult you local Nokia After Market Services office more information.

GPS Testing Engine

This setup will be used for testing of the GPS Engine at Nokia Authorized Service Centers. Both Galvanic and Radiated tests will be supported. The GPS Test component in Phoenix will provide functionality to perform these tests. Refer to the *Troubleshooting - GPS* section for more details regarding GPS Engine troubleshooting.

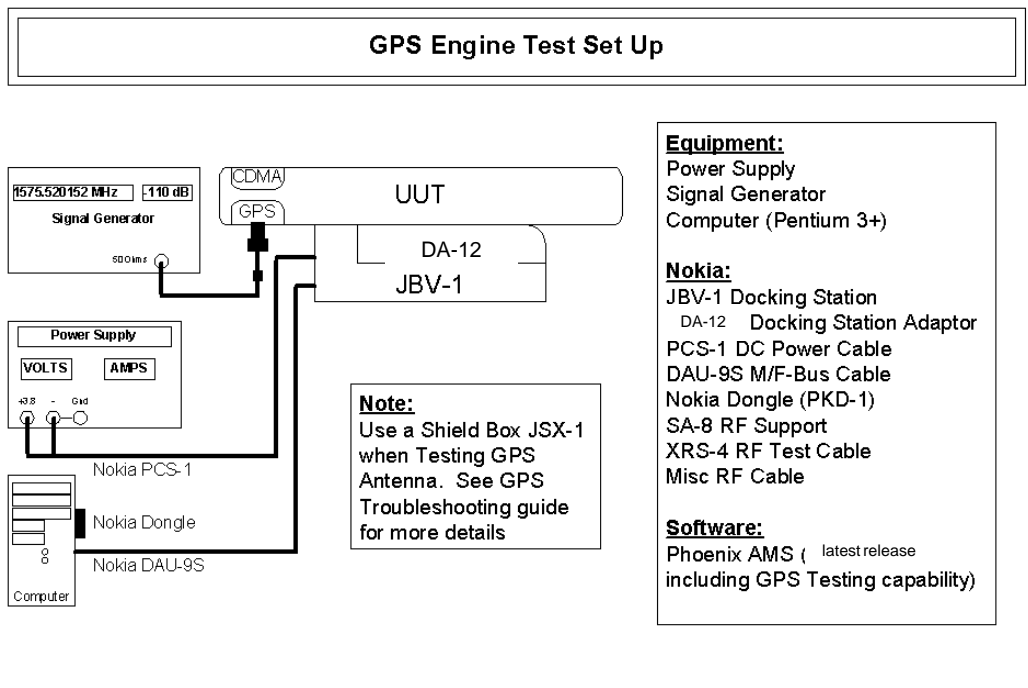

Figure 1: GPS Galvanic Testing

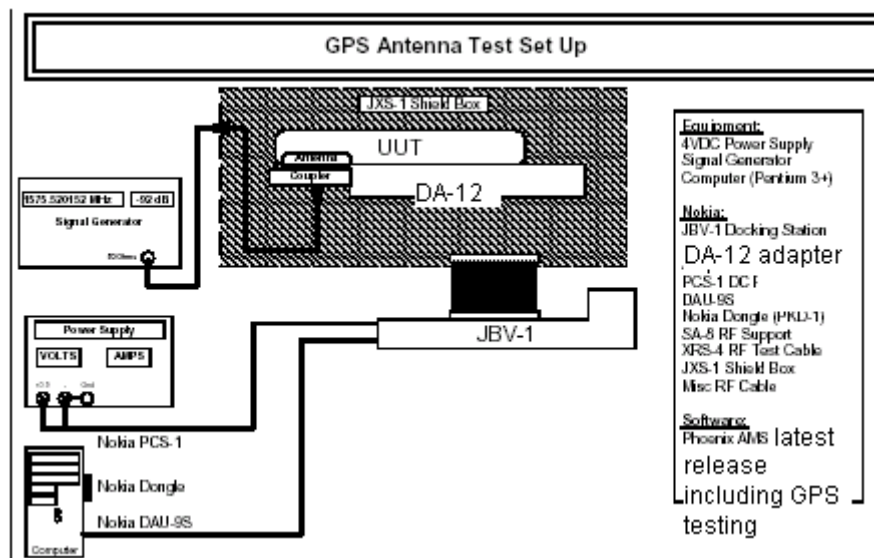

Figure 2: GPS Radiated Testing

GPS Testing Equipment

- Power Supply
- Signal Generator up to 2 GHz
- Computer (Pentium 3, W2000)

- JBV-1 Docking Station
- DA-12 Docking Station Adaptor
- PCS-1 DC Power Cable
- DAU-9S M/F-Bus Cable
- RF Test Cables (for GPS RF Port)
- Latest Release Phoenix AMS version w/ GPS Test Component

